

# MERIVOBX

## ► Tiroir - tiroir sous évier - tiroir pour siphon

VANHOECKE®

Société		<input type="checkbox"/> Offre	<input type="checkbox"/> Bon de commande
Place		Commandé par	
Code postal		E-mail	
Téléphone		Fax	
Commission		Delai de livraison	

<b>Côtés tiroir</b> <input type="checkbox"/> blanc soie <input type="checkbox"/> gris orion <input type="checkbox"/> gris indium	<b>Fond + dos</b> <input type="checkbox"/> blanc <input type="checkbox"/> gris orion <input type="checkbox"/> gris indium	<b>Coulisses</b> <input type="checkbox"/> BLUMOTION <input type="checkbox"/> TIP-ON BLUMOTION <sup>(1)</sup>	<b>Fixation face</b> <input type="checkbox"/> EXPANDO <input type="checkbox"/> à visser <input type="checkbox"/> INSERTA <input type="checkbox"/> EXPANDO T <input type="checkbox"/> cheville <input type="checkbox"/> pour face alu
<b>Profil de distance<sup>(2)</sup></b> <input type="checkbox"/> blanc <input type="checkbox"/> gris orion <input type="checkbox"/> noir <input type="checkbox"/> platina gris argent	<b>Emballage</b> <input type="checkbox"/> ProBOX <sup>(3)</sup>	<b>Nattes antidérapantes</b> <input type="checkbox"/> fibre-plastique <input type="checkbox"/> vinyl-fiber <input type="checkbox"/> flock	

Spécifications											
Nr.	Quantité	Type de tiroir <sup>(4)</sup>	Largeur corps		Profondeur tiroir	Poids <sup>(5)</sup>	Mur latéral E	Front E <sup>(6)</sup>	Options		
			Mesure intérieure	Profil de distance					Stabilisateur <sup>(7)</sup>	Séparation	Entraîneur <sup>(8)</sup>
1				<input type="checkbox"/> 1 <input type="checkbox"/> 2	mm	kg					
2				<input type="checkbox"/> 1 <input type="checkbox"/> 2	mm	kg					
3				<input type="checkbox"/> 1 <input type="checkbox"/> 2	mm	kg					
4				<input type="checkbox"/> 1 <input type="checkbox"/> 2	mm	kg					
5				<input type="checkbox"/> 1 <input type="checkbox"/> 2	mm	kg					
6				<input type="checkbox"/> 1 <input type="checkbox"/> 2	mm	kg					

Spécifications - extension tiroir pour siphon <sup>(10)</sup>					
Type de tiroir	Simple - double	Simple - double	Double	Double	Simple - double
Nr.	X <sup>(9)</sup>	Z1	M <sup>(11)</sup>	Z2	Y <sup>(9)</sup>
	mm	<input type="checkbox"/> 160 mm <input type="checkbox"/> 300 mm	mm	<input type="checkbox"/> 160 mm <input type="checkbox"/> 300 mm	mm
	mm	<input type="checkbox"/> 160 mm <input type="checkbox"/> 300 mm	mm	<input type="checkbox"/> 160 mm <input type="checkbox"/> 300 mm	mm
	mm	<input type="checkbox"/> 160 mm <input type="checkbox"/> 300 mm	mm	<input type="checkbox"/> 160 mm <input type="checkbox"/> 300 mm	mm

Specificaties-uitbreiding Spoelbaklade			
Type de tiroir	Gauche	Récupération	Droit
Nr.	X <sup>(9)</sup>	Z1	Y <sup>(9)</sup>
	mm	<input type="checkbox"/> 470 mm <input type="checkbox"/> 570 mm <input type="checkbox"/> 770 mm	mm

**ENCOMBREMENT**

X	Min.
N	85,5
M	108
K	146
E	209

Espace libre incl. pour monter le tiroir

- (1) TIP-ON BLUMOTION n'est pas disponible chez tiroirs sous évier  
 (2) Profil symétrique: épaisseur 25 mm  
 (3) Quantité de commande minimale: 4 pièces  
 (4) Voir page suivante  
 (5) Le poids des coulisses dépend de la longueur de la coulisse: voir page suivante  
 (6) R: galerie, GH: verre haut, GL: verre bas  
 (7) Le stabilisateur latéral est recommandé  
 (8) Pour les tiroirs à l'anglaise M et K en métal  
 (9) X et Y peuvent être variables, mais doivent être de 159 mm au minimum.  
 (10) Toujours équipé d'un dos de tiroir M  
 (11) M peut être variable, mais doit être 97 mm au minimum.

Remarque:

# MERIVOBX

► Informations supplémentaires  
Dimensions



## MERIVOBX TIROIR BLUMOTION ou TIP-ON BLUMOTION

PROFONDEUR + POIDS

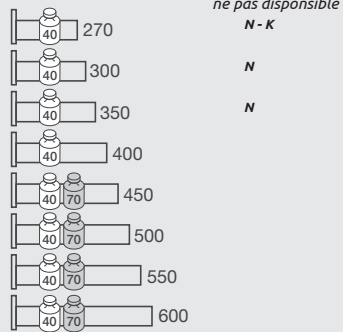

## MERIVOBX TIROIR SOUS ÉVIER BLUMOTION

*ne pas disponible*

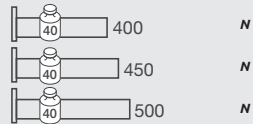

## MERIVOBX TIROIR DE SIPHON BLUMOTION ou TIP-ON BLUMOTION

*ne pas disponible*

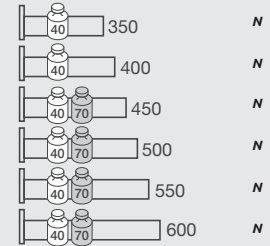

### DIMENSION TIROIR SOUS ÉVIER

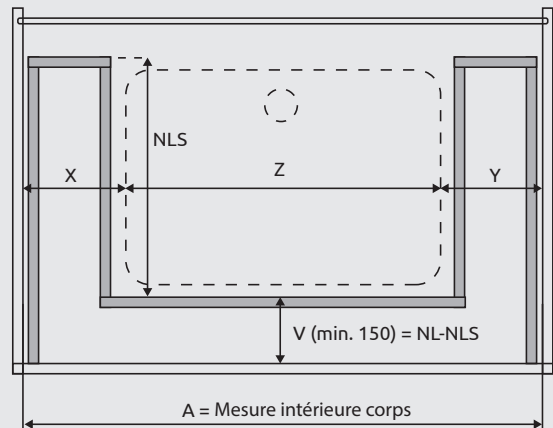
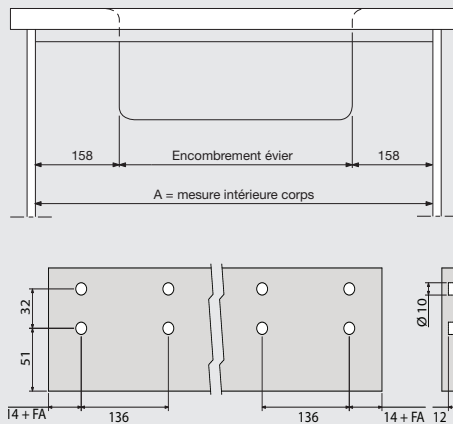

### DIMENSION TIROIR DE SIPHON SIMPLE

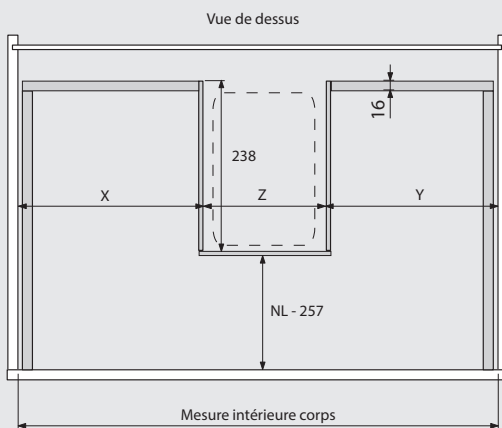

### DIMENSION TIROIR DE SIPHON DOUBLE

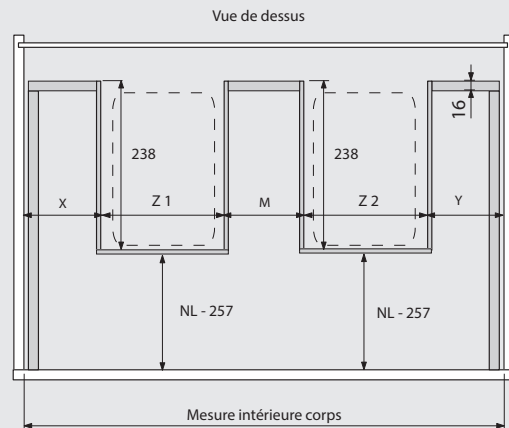

# MERIVOBX

► Informations supplémentaires

Tiroir

VAN  HOECKE®

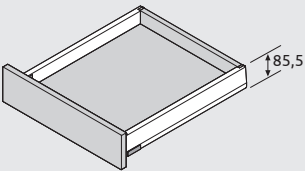
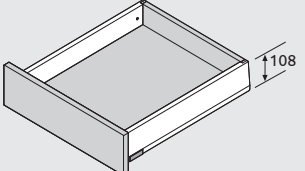
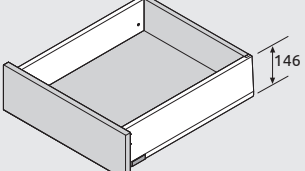
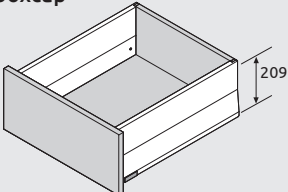
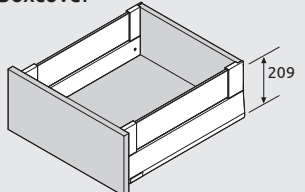
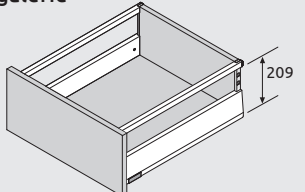
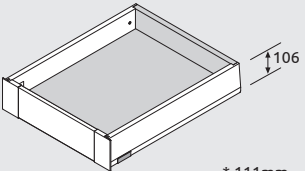
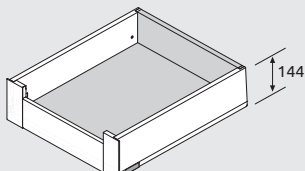
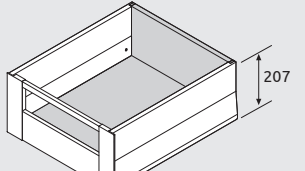
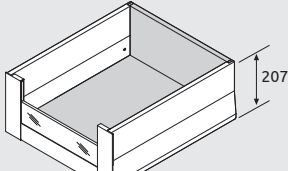
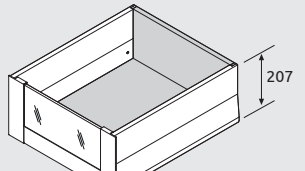
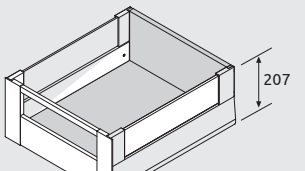
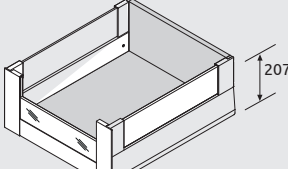
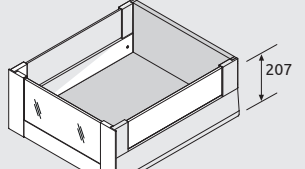
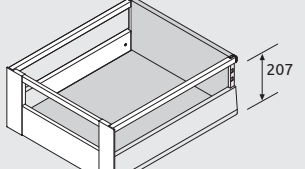
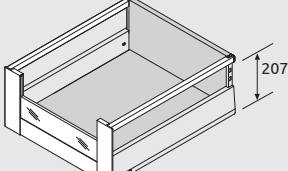
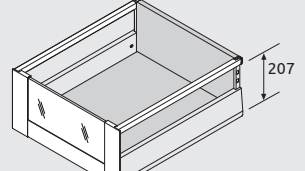
TIROIR	<b>N</b>  85,5	<b>M</b>  108	<b>K</b>  146
	<b>E boxcap</b>  209	<b>E boxcover</b>  209	<b>E galerie</b>  209
	<b>M/Z</b>  110,5 <small>* 111mm avec chariot</small>	<b>K/Z</b>  144	<b>E/Z boxcap - galerie</b>  207
TIROIR À L'ANGLAISE	<b>E/Z boxcap - verre bas</b>  207	<b>E/Z boxcap - verre haut</b>  207	<b>E/Z boxcover - galerie</b>  207
	<b>E/Z boxcover - verre bas</b>  207	<b>E/Z boxcover - verre haut</b>  207	<b>E/Z galerie - galerie</b>  207
	<b>E/Z galerie - verre bas</b>  207	<b>E/Z galerie - verre haut</b>  207	

# MERIVOBX

► Informations supplémentaires

Tiroir sous évier et tiroir pour siphon simple

VAN  HOECKE®

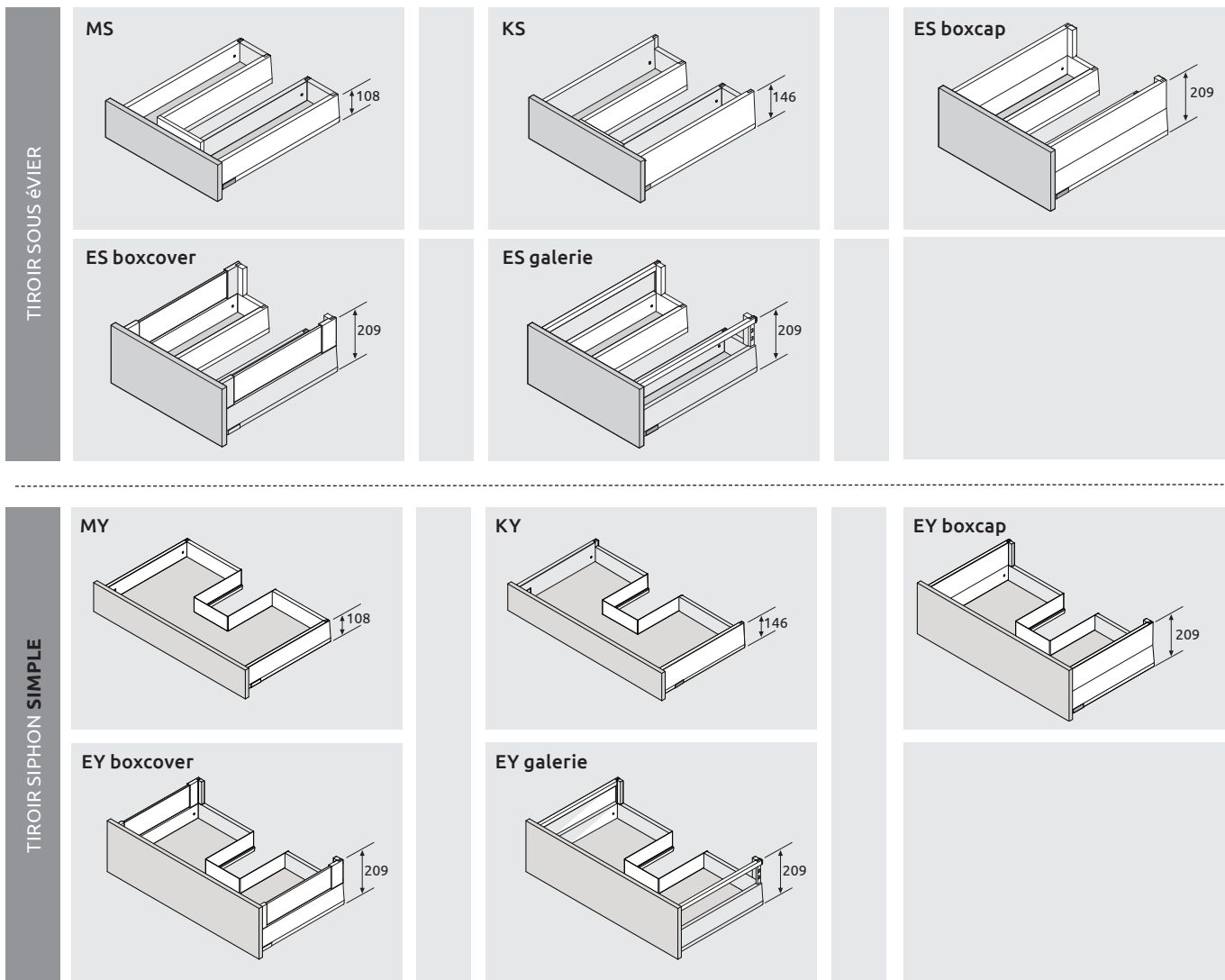

# MERIVOBX

► Informations supplémentaires  
Tiroir pour siphon simple et double

VAN  HOECKE®

TIROIR SIPHON SIMPLE

MY/Z

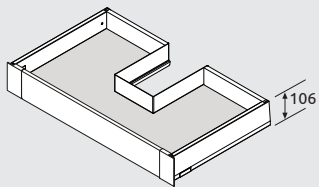

EY/Z boxcap - verre bas

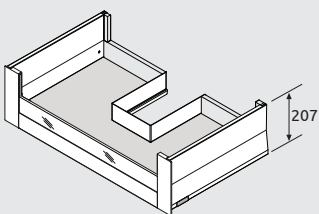

EY/Z boxcover - verre bas

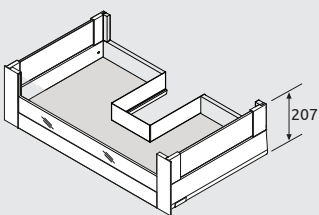

EY/Z galerie - verre bas

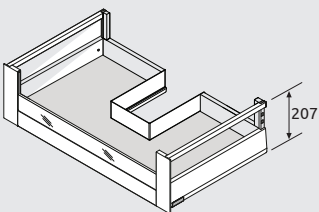

KY/Z

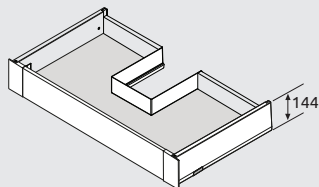

EY/Z boxcap - verre haut

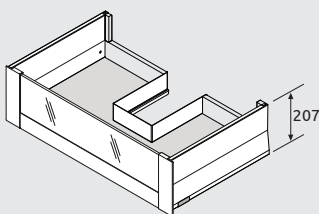

EY/Z boxcover - verre haut

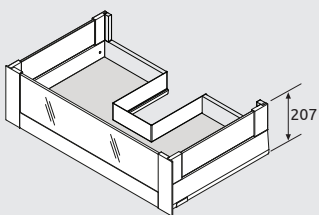

EY/Z galerie - verre haut

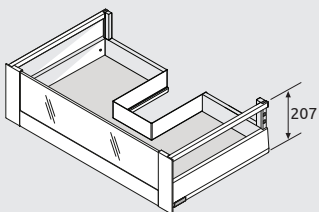

EY/Z boxcap - galerie

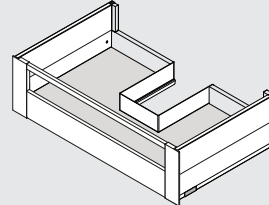

EY/Z boxcover - galerie

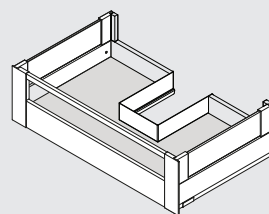

EY/Z galerie - galerie

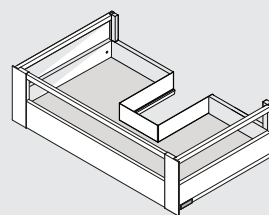

TIROIR SIPHON DOUBLE

MY2

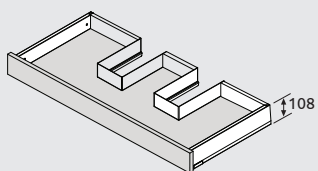

EY2 boxcap

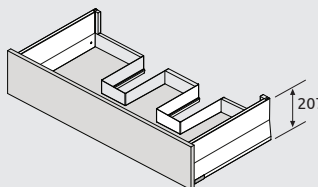

KY2

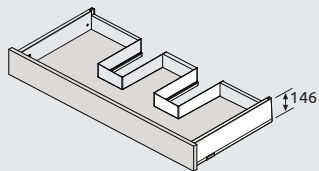

EY2 boxcover

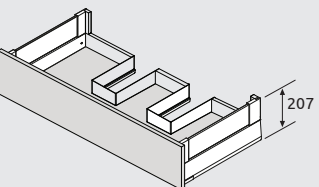

EY2 galerie

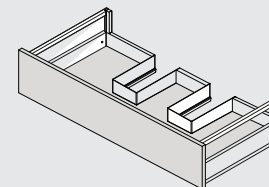

# MERIVOBX

► Informations supplémentaires  
Tiroir pour siphon double

VAN  HOECKE®

TIROIR DE SIPHON À L'ANGLAISE **DOUBLE**

MY2/Z

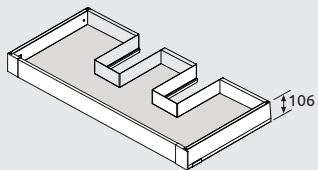

KY2/Z

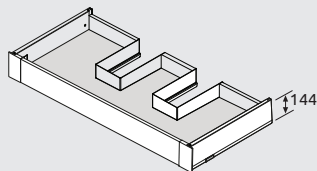

EY2/Z boxcap - galerie

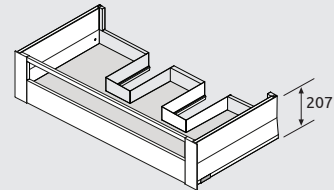

EY2/Z boxcap - verre bas

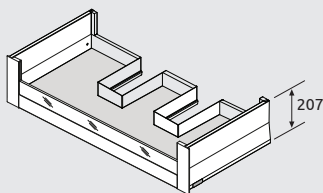

EY2/Z boxcap - verre haut

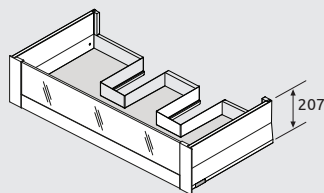

EY2/Z boxcover - galerie

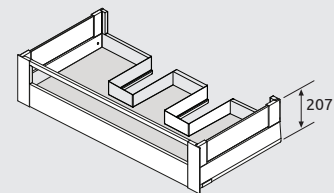

EY2/Z boxcover - verre bas

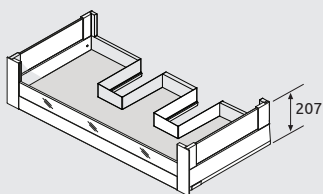

EY2/Z boxcover - verre haut

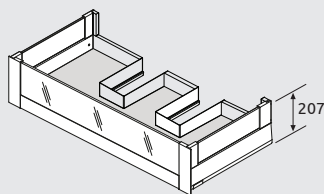

EY2/Z galerie - galerie

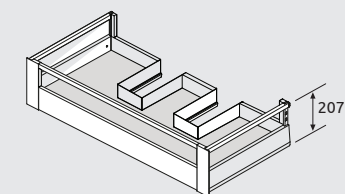

EY2/Z galerie - verre bas

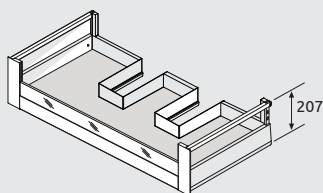

EY2/Z galerie - verre haut

